



User Manual

V9.0C/M Professional Edition 2019-02-05

Contents

Main Features	P4
Installation Instruction	P4
The KHG exterior & features	P5
Quick Install	P5
Main Display	P8
Main Control of KHG	P8
KHG System Setup	P11
The Meaning of Log Field	P17
Firmware Upgrade	P17
AIM Calibration	P19
Error Message and Troubleshooting	P20
Additional User Instructions	P23
Appendix	P25
Display Panel Short-Cuts	P25
Static Testing	P26
Changelog	P27

Main Features

- The resolution is 0.1 dKH. This is the minimal resolution. If signal noise have reduced, the self-learning algorithm will modify the suitable resolution automatically.
- Continuous measuring test accuracy is +/- 0.1 dKH.
- Measurement range: 5 - 12 dKH.
- Use only one reagent for each test. The used reagent goes directly to the aquarium without any safety concern. Each test only takes around 3 ~ 4 cc. reagent.
- It supports remote terminal function to monitor and control the instrument via any web browser on the same local network. No need to install any software or APP. Simply use web browser for operation.
- SD memory card preinstalled for the long-term data logging.
- Supports graphical presentation of the records.
- Version "C" has an automatic dKH controlling feature. It automatically calculates how much sodium bicarbonate solution should be added to the aquarium with the reference of the desired dKH target value, aquarium total water volume, and current testing value. Then the controller dose-in the solution accordingly.
- Automatic measuring interval can be set from 60 to 240 minutes. Each measurement takes about 3 to 7 minutes.
- With the "C" version, no need to change the existing calcium reactor and alkalinity dosing. We do recommend to slightly decrease your current dKH dosing parameters below your desired target, and let KHG do the final fine tuning for your tank automatically.
- Supports downloadable firmware update.
- Supports expansion module for seamless integration into third party aquarium control systems.

Installation Instruction

The KHG exterior & features

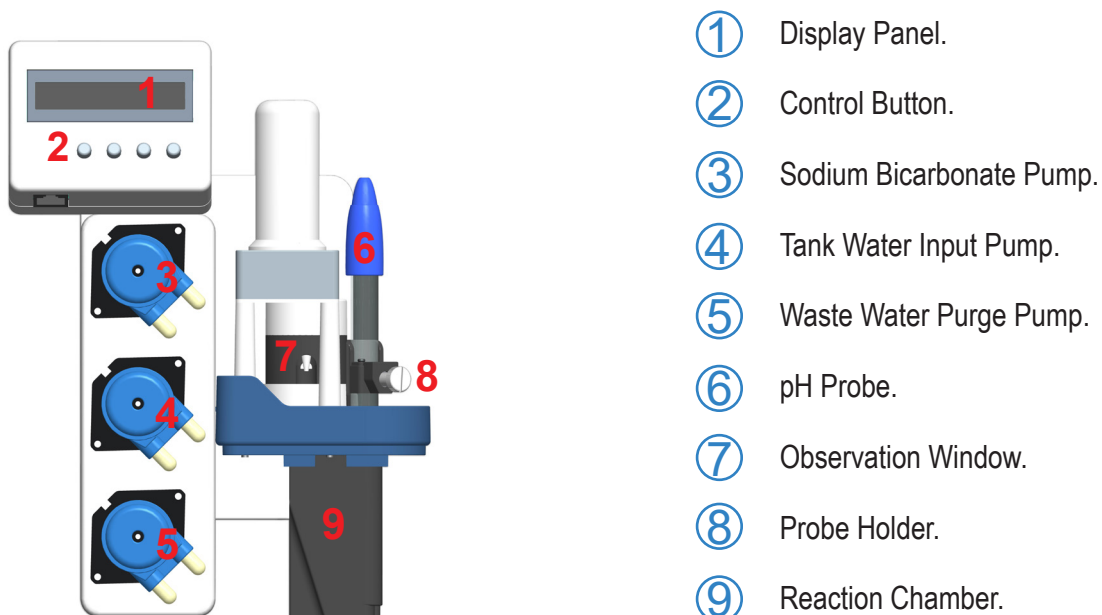

(Figure 1)

* Please note, "M" version does not include Sodium Bicarbonate Pump

Quick Install

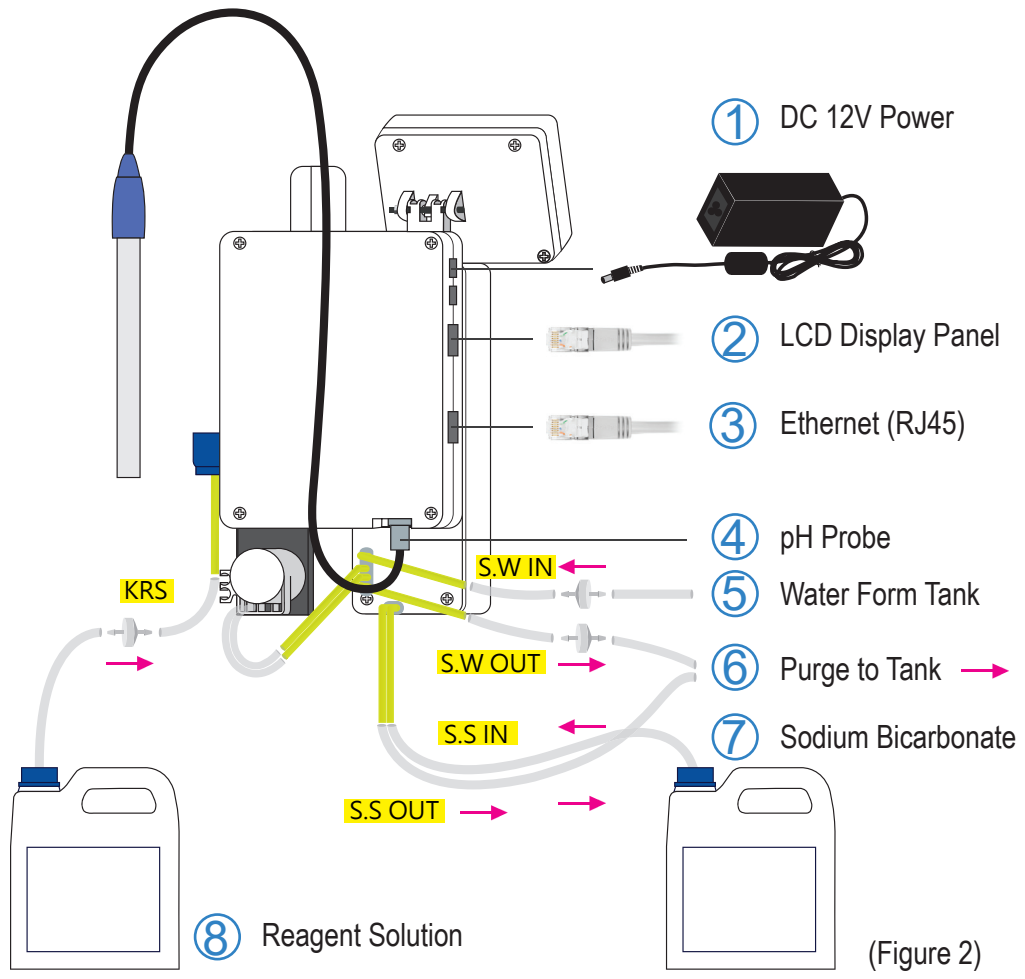

(Figure 2)

1. KHG display panel

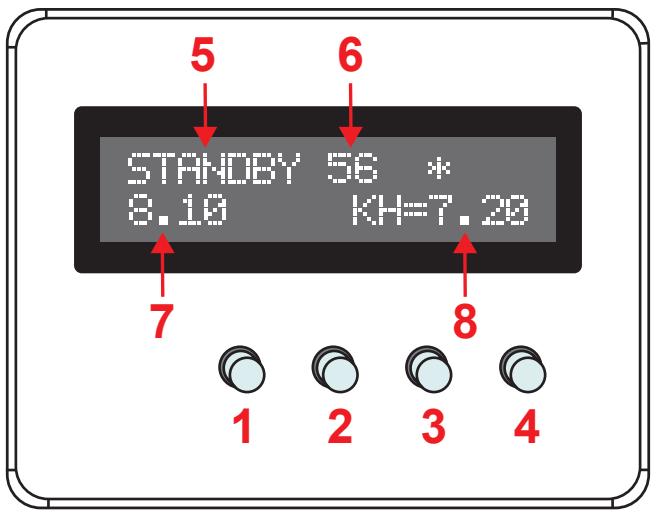

(Figure 3)

- ① Number 1 button.
- ② Number 2 button.
- ③ Number 3 button.
- ④ Number 4 button.
- ⑤ Current system status.
- ⑥ The time remaining until next testing.
- ⑦ The last pH value obtained by the KHG.
- ⑧ The last dKH value obtained by the KHG.

2. When installing KHG, please ensure the KHG is placed on level ground and is completely upright (Figure 4). At least a construction grade levelling tool must be used to make sure the placement of KHG is level on the X, Y, and Z axis. Complete levelling is crucial as to keep the sodium bicarbonate solution from dripping on the optical and electrical components before entering the reactor chamber. KHG will fail if solutions contaminates the optical and electronics.
3. Please keep KHG no more than 100 centimetres away from your tank. It is necessary to keep KHG within this distance to ensure the sample delivered by the SW IN tube is same as your concurrent tank water.
4. For "C" model, there are 5 silicon tubes ends that connects outside of the KHG. The uses of each are as follows :

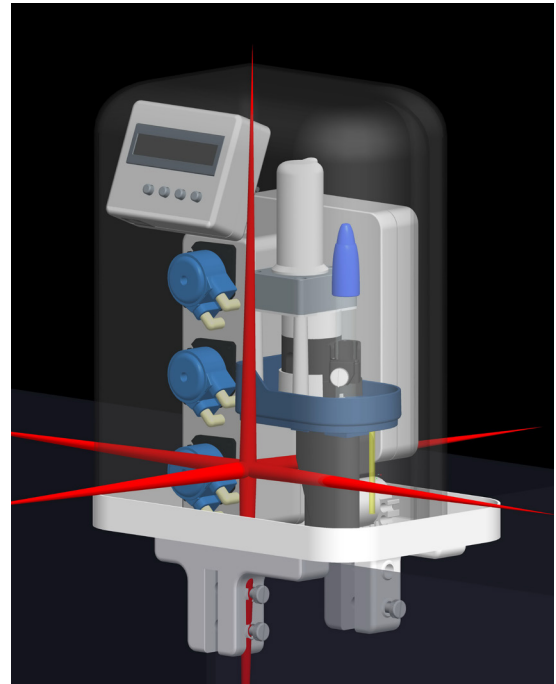

(Figure 4)

- **SW IN**

Saltwater in. This tube connects to your tank water for the sample to be taken. Source of tank water must be filtered by 500 micron or less to keep tubes free of blockage. Please make sure the medical grade check valve (included with KHG) is installed in the right direction.

- **SW OUT**

Saltwater OUT. This tube are for purging reaction chamber water. Please make sure the medical grade check valve (included with KHG) is installed in the right direction.

- **S.S. IN**

Sodium Bicarbonate Solution IN. This tube connects to your Sodium Bicarbonate Solution Reservoir. Please note, "M" version does not have this tube.

- **S.S. OUT**

Sodium Bicarbonate Solution OUT. This tube connects to your tank or sump. It delivers the sodium bicarbonate solution to your tank to use in combination with the KH auto correction feature of KHG. Please note, "M" version does not have this tube.

- **KS**

Reagent Solution. This tube connects to the KHG reagent solution bottle.

5. pH probe calibration instruction :
 - A. Rinse pH probe with distilled water, and pat dry with fine tissue paper. When drying, please do not twist dry probe surface with the tissue paper as this will damage the coating on the probe sensor, and will render the probe inaccurate.
 - B. Please insert the pH probe into pH 7.0 calibration solution of at least 1.5 cm deep. Shake lightly but continuously for one minute. When the pH on the LCD panel has become steady, Press and hold number 2 and number 4 buttons simultaneously for 3 second until you hear a beep and release both buttons. Now the pH 7.0 calibraion is done.

- C. Before proceeding to pH 4 calibration, please rinse pH probe with distilled water and pat dry with fine tissue paper. Care must be taken not to twist dry with tissue paper as described in point “a” above.
- D. Please insert pH probe into pH4 solution of at least 1.5 cm deep. Shake lightly but continuously for one minute. When the pH on the LCD panel has become steady, Press and hold number 1 and number 4 buttons simultaneously for 3 seconds until you hear a beep and release both buttons. Now the pH 4.0 calibration are complete.
- E. You must perform the 2 point calibration in the order of pH7 first and pH4 follows. You must complete all calibration before proceeding to next installation step. 2 point calibrations must be performed every time you attempt to recalibrate.

6. If you are using the Lab Grade glass electrode, Please insert the calibrated pH probe until the cap of pH probe is level with the Red line. (Figure 5) Hand tighten the white knob to secure pH probe in place. Over tighten the white knob could break the glass sleeve of pH probe. But if you are using the blue color plastic electrode, please refer to (Figure 6), Black/White cap glass electrode please refer to (Figure 6B) for electrode alignment.

(Figure 5)

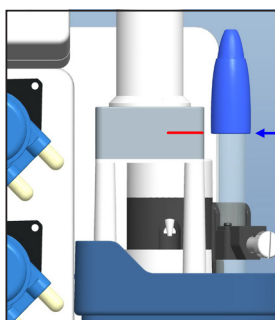

(Figure 6)

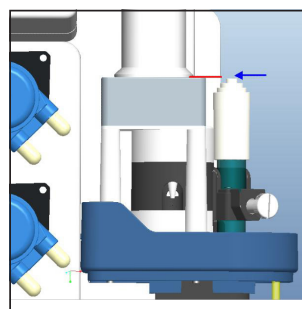

(Figure 6B)

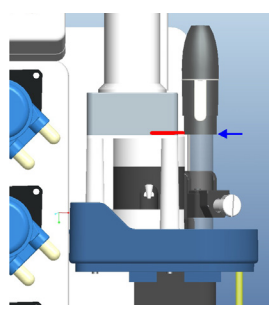

7. Please recheck and make sure all tubes are connected as instructed above. Go to your browser and click on “SW Tube De-Gas” to purge air from your tank water inlet tube. When the pump runs exceeding the settled secure value of No_SW_ERR, KHG will purge the sea water already sucked and try the second time of sea water sucking. When the water pump runs more than the secure setting No_SW_ERR again, KHG will sound the alarm and display SW>ERR error message, at this time, please check if the sea water suction line works smoothly, and press button 4 on the KHG LCD display for seconds down, let go when hear the beep, the error message will be removed.

(Figure 7)

8. Please click on the “KS De-Gas” on your browser to purge air from your KHG reagent solution tube. Please look into the observation hole (Figure 7) until you see reagent solution is dropping at the rate of one drop per 3 seconds. Please let reagent solution to drop at least 10 times before cancelling the air purging by clicking on the “RESET” in your browser screen, or press and hold number 4 button for 3 seconds to stop the purging procedure. If KHG shows “KS_ERR”, there may be blockage in the tube and KHG will force into areboot. At the same time please check if the tube is free from blockage and make sure there are reagent solution in the storage bottle.

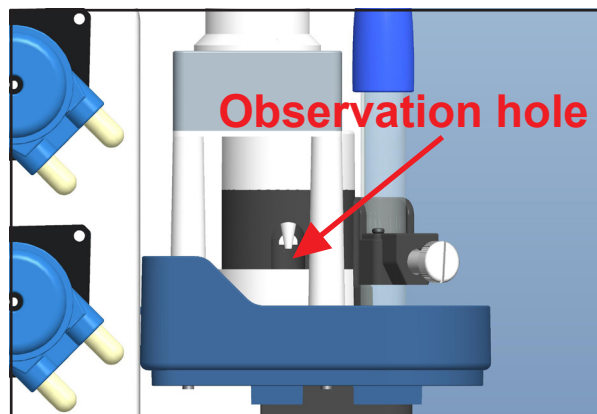

9. Next please key in your last known dKH value into the “Last KH (dKH)” under the “System Setup”. Please also make sure the number you entered is not 1.5 dKH away from your desired alkalinity target level (“KH Auto Correction”). Next click on “SAVE” to save your settings and KHG will enter a forced reboot.
10. After a successful reboot of KHG, the LCD display will show STANDBY. Please enter KHG main control page in your browser, and click on “GET dKH”. KHG will perform a full test. After the test has been done, KHG will return back to standby mode.
11. Please note, if the alkalinity obtained by the KHG deviate by 1.5 dKH from your desired dKH setting (“KH auto correction”), KHG will show error messages. KHG will assume this is a major deviation and will suspend all subsequent dosing of sodium bicarbonate solution and enter into a forced reboot and return back to standby mode. If the tested value is larger than the “KH auto correction” by +1.5 dKH, KH>ERR will appear. If the tested value is less than the “KH auto correction” by -1.5 dKH, KH<ERR will appear.

Main Display

Please make sure the RJ45 network cable is securely attached and connect KHG to your home router or LAN. After switching on KHG, the display panel will show the IP and port number automatically assigned by the network DHCP (Figure 8). Please write down the IP and port number shown on the display, and enter it to the browser of your computer or mobile device to access controls of the KHG.

If your network DHCP did not automatically assign an IP to KHG, the default IP will be 192.168.1.10.

For example, if the display were shown as Figure 8, then you should enter <http://172.22.20.158:8090> into your browser. When the login window appears as Figure 9, enter the password (default setting is "Admin") and Click Login button, then you will be able to access the controls of KHG as Figure 10.



(Figure 8)

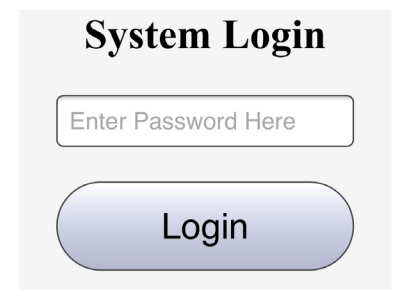

(Figure 9)

Main Control of KHG

1. Get dKH

Press to test and obtain KH value. Counter will be reset after the testing is completed.

2. Purge Chamber

Press to purge and empty all solutions in the reactor chamber. This must be performed every time you intend to move the KHG. It is crucial to purge reaction chamber to prevent solutions damaging the optical lens and other electronic components. Failure to purge chamber could result in KHG failure.



(Figure 10)

3. SW Tube De-Gas

Press to pump saltwater sample into the reaction chamber. This is normally only used at initial setup of KHG, or after reassembly of the step motor head. By pressing it, saltwater will pump water up the feeder tube, purging gas from the tube. If there were blockage in the feeder tube, after a preset amount of time no water has been pumped into the reaction chamber, the display would show S.W_ERR error message.

4. KS De-Gas

Press to purge gas from the feeder tube of KH reagent solution. Please look into the observation window to check if KH reagent solution are flowing into the reaction chamber. After seeing reagent solution is flowing and the LED is blinking steadily, please press the "RESET" button to stop.

5. ENG Mode ON

Press to enable Engineering Mode for special functions and advanced setup feature.

6. ENG Mode OFF

Press to disable Engineering Mode.

7. Test KH doser

Press to test if the Sodium Bicarbonate solution is pumping.

8. Test accelerator

Press to test if the reaction chamber agitator is functioning normally.

9. RESET

Press to reset warning signals. Also used to stop KS De-Gas function.

10. Refresh

Press to refresh your browser display on your computer or mobile devices.

(Figure 11)

11. Reboot

Press to force reboot of the KHG.

12. Display Record

Press to display the log.

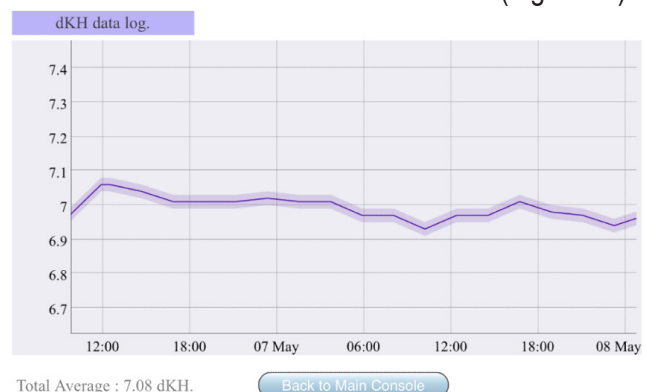

13. Line Chart

Press to display the records by graphical presentation. Line Chart can record up to 168 records. Exceeding that, new record will overwrite older records. User can use left button of the mouse to drag in four directions to select an area to enlarge. Double click will return to normal chart size. Click on "Back to Main Console" will return back to the main setup page. Please note, Line Chart will not display correctly if

the date and time is not correctly recorded, or if the KHG internal clock battery drained out, or if KHG was not able to obtain NTP time from the web time servers.

14. System Setup

Press to enter into system setup screen.

15. Log out

Press to Log out of KHG.

Definition of the data shown on the bottom of the main control page (Figure 12) :

- **Last KH: n.nn**

This is the last dKH value obtained by the KHG.

- **pH: n.nn**

This is the last pH value obtained by the KHG.

- **CKI = nn**

This is the testing interval (unit : minutes). Testing Interval can be changed in the KHG system setup.

- **NT: nn min**

This is the time (minutes) remaining until next testing.

- **W: nnn**

This is the step motor setting value to control how many steps motor will turn to pump water into the reaction chamber (unit : steps).

- **AutoMode: n**

Automatic testing mode (1 = ON, 0 = OFF).

- **P: STANDBY**

Current system status.

- **SYS: READY**

Sublevel control status (For support staff use only).

- **L.Time: MM/DD hh:mm**

Date and time of the last testing performed.

- **C.Time: MM/DD hh:mm**

Date and time of the current testing performing.

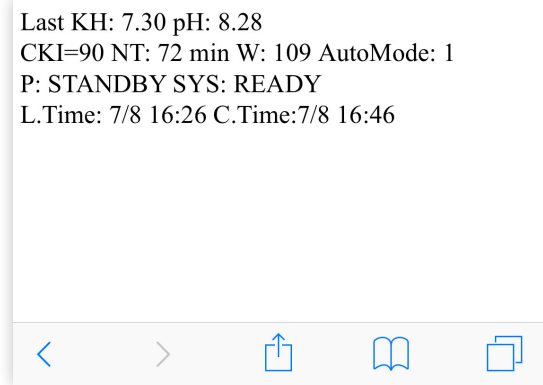

Last KH: 7.30 pH: 8.28
CKI=90 NT: 72 min W: 109 AutoMode: 1
P: STANDBY SYS: READY
L.Time: 7/8 16:26 C.Time:7/8 16:46

(Figure 12)

KHG System Setup

1. Auto mode :

Default value is 1.1 means KHG is in automatic mode. Any other value will disable automatic mode.

2. Check intervals (Min) :

This is to set the minutes intervals between each KHG test. Unit is minutes. We recommend setting the intervals to 180 minutes. You can shorten the testing interval time, but that will also use up KH reagent solution faster.

3. No_SW_ERR :

This is to set the alarm if the number of steps of the step motor has turned, but still not enough water has been pumped into the reaction chamber. Default value is from 140 to 160. The unit is number of steps for the step motor. This is useful to determine if there were blockage in the SW feeder tube. Depending on how far your KHG is placed from the tank water source and how much head there are to pump water into the reaction chamber. You can adjust this value to best suit your environment. However, caution must be taken if you deviate from the recommended range too far, it may result in excessive water being pumped out of your system.

4. No_SW_ERR Try: :

User can set up the try times when KHG get SW ERR, the default value is 2.

5. Wash Rate :

User can set up the times of clean chamber it is for the user who put KHG away from his tank. BUT IT is what we do not recommend . the default value is 2.

6. pH4 (mv) :

pH4 reference voltage, do not change. When making pH calibration, this value can be operated from the control panel. Please note, this field will not display unless Engineering Mode is activated.

7. pH7 (mv) :

pH7 reference voltage, do not change. When making pH calibration, this value can be operated from the control panel. Please note, this field will not display unless Engineering Mode is activated.

8. Magic Seeds :

Read-Only value, for R&D purpose only. Please note, this field will not display unless Engineering Mode is activated.

9. Err Range (dKH) :

This is to set the variance range in comparison to the previous dKH value. If the difference of this test deviates a preset error range from the last known dKH value, the KHG will setup second testing immediately to verify the result. The unit of value is dKH. We recommend to set it at 0.5 dKH.

10. Err Try :

This is to set the number of retest to be taken, if the Err Range condition were met.

11. Log Retry:

User can set up when KHG trying to get the KH value again, is it recorded ? 0 is do not record (Default), 1 is record. If you are a newbie, we suggest that you temporarily set it to 0.

12. > or < 1.5 Alert :

If the alkalinity obtained by the KHG deviate by 1.5 dKH from your desired dKH setting ("KH auto correction") need an alert ? 0 No, 1 is YES. If you are a newbie, we suggest that you temporarily set it to 0.

13. KH Round off 2nd Dec :

Set to round off second decimal place of your KH readings. Enter "0" to close this function, and enter "1" to activate. For example, when activated, value of 7.68 will be recorded and displayed as 7.7, 7.62 will be recorded and displayed as 7.6. Please note, this field will not display unless Engineering Mode is activated.

14. Last KH (dKH) :

This is only used after a system reset or diagnostics, or if instructed by a qualified KHG support staff.

15. ADJ KH (dKH) :

This is to force adjustment (correction) of the value obtained by KHG. This is normally used if you believe there is a constant deviation between the value tested by KHG versus another test kit, and you believe KHG's value need to be adjusted every time. You can enter the deviation in here. The adjustment value can be either positive or negative. Please note, upon setting up a new KHG, please make sure you have at least 5 successful KH readings before making changes to this field.

16. Enable KH Auto :

Enter "1" to activate automatic mode. Any other number will cancel the automatic mode. "M", For the "M" version, CO2 solenoid power control module for calcium reactor should be used for this to function.

17. S.Raise KH ml/L ability:

the solution raise KH for ml / L ability. This means that whether or not any KH lift solution is used, please provide how much dKH can be increased by 1 L (1000 cc) of seawater per ml (cc) for this lift solution. The default is 2.17, because KHG recommends a 65g / 1L baking soda solution, and this baking soda solution can lift a liter of seawater 2.17dKH. Please be careful to use this function, it is very powerful but also very dangerous, wrong calculations can cause serious damage.

18. KH auto correction :

This is to set your desired tank dKH value. The unit is dKH. As a full functioning dKH controller, KHG not only monitors your tank alkalinity, but with KH auto correction, KHG will also actively maintain your desired dKH level. Regardless if you normally maintain your tank alkalinity by kalkwasser, calcium reactor, or alkalinity dosing, we highly recommend you set your usual alkalinity dosing to a level slightly below your desired target, and let KHG do the final fine tuning for your tank automatically. (Feature not available fo M model.)

For example. If your desired tank dKH is 7.5, then please set this number at this field. At the same time, please setup your normal alkalinity dosing to near 7.0, and let KHG do the rest. KHG will calculate the difference of the actual tank alkalinity level versus the desired target. Taking account of the total tank volume, KHG will calculate how much sodium bicarbonate solution to add after each testing."M" For the "M" version, CO2 solenoid power control module for calcium reactor should be used for this to function.

19. M.L.Q :

MLQ sets the maximum amount of sodium bicarbonate that KHG can add at any given time. Unit is milliliter (ml). This is the safety feature for your tank to prevent too much alkalinity to be added into the tank at any given time. Maximum value is 1000. (Feature not available for "M" model.)

For example, if this time KHG determines 80 ml should be added into your tank, but you have set the MLQ at 35 ml, then KHG will only add 35 ml this time into the tank.

20. Total volume (L) :

This is to set the total water volume of your tank in Liters. KH auto correction will use this data to calculate how much sodium bicarbonate solution are needed after each testing. (Feature not available fo M model.)

21. KH Doser Pump:

User can set up which baking soda pump to use. "1" is default for built-in baking soda pump (not applicable for "M" model). If you want to use CCM, please set this value to "2". If you want to use Kamoer step pump , please set this value to "8" (available both for "C/M" model).

22. C.R suspend time:

If the alkalinity obtained by the KHG exceed from your desired dKH setting ("KH auto correction"), After KHG restarts, suspension time (unit:minutes) required for the calcium reactor. Please note that this setting cannot be greater than Check intervals.(During the period when the CCM shuts down the calcium reactor, a flashing "!" symbol will appear in the lower right corner of the LCD screen.)

23. Auto activation :

This is a very creative new feature of KHG. if set this value to "1", after 15 ~ 20 runs, the KHG will enter the "Reactivation mode" to increase the sensitivity and the life of the reaction chamber.



24. SYS_Sound :

Set as "1", system sound will be ON. Any other number will deactivate system sound. Canceling system sound will NOT silence alarm.

25. PORT :

This is to be used only as instructed by your network administrator. Default value is 8090.

Timezone :

26. This is to set time zone (UTC) at your location. Please refer to https://en.wikipedia.org/wiki/Time_zone for more details.

27. Enable NTP :

Whether to enable NTP function.

NTP Server :

28. This is only to be used if instructed by your network administrator.

Enable NTP :**29. MAC :**

MAC Address of this KHG and cannot be changed.

30. S/N :

Serial Number of this KHG and cannot be changed.

31. Manufacture :

Factory date or last maintenance date.

32. Version :

Display current firmware version.

33. F/W update :

Display the date of firmware last update.

34. E.D.A.P Key :

External Data Access Permission Key. This is case sensitive alpha-numeric eight digits key that is required when third party controller systems need to access KHG through API. Please note, this field will not display unless Engineering Mode is activated.

35. SAVE :

Save settings and record into memory. KHG will reboot after saving.

36. Force reverse calibration:

Please put the KH value you test from 3rd party test kit in REF.KH (dKH) box then click "Force reverse calibration" then KHG will reboot itself. KHG will be enforced to accept new KH value. This function is more powerful than ADJ function, that is to say when user use this function the ADJ function will be back to "0" automobile.

PLEASE NOTE:

If a red error message appears : **Unable to execute : Insufficient record of stability.**

This means that there are no three consecutive stable test records, so calibration is prohibited. The way to solve, please do not change any settings and make your KHG continue to run three times, and do not make any mistakes. Within three consecutive operations, If the error is within 0.5dKH, the correction function will appear.

If a red error message appears : **Unable to execute : Excessive deviation.**

This means that the error of three consecutive test data exceeds 0.5dKH , so calibration is prohibited.

The way to solve, please make your KHG perform a **Static Testing** to determine the source of the instability of the test results, whether it is KHG, or your aquarium environment. When the static test is completed, calibration it at the same time.

If a red error message appears : **Unable to execute : Unhandled error..**

This means that KHG has an error, and this error has not been manually removed, for security reasons, Correction is prohibited. Solution, Please press "RESET" or press the fourth button on the LCD screen for 3 seconds until you hear B and release. After the error is removed, don't change any settings. please make your KHG running three times, if the error within three consecutive operations is 0.5dKH , the calibration function will appear.

37. Firmware Upgrade :

Please refer to the Firmware Upgrade function section for more details (Page 12). Please note, this field will not display unless Engineering Mode is activated.

38. AIM Calibration :

Advanced Interface Module Settings. Please refer to the AIM Calibration function section for more details (Page 19). Please note, this field will not display unless Engineering Mode is activated.

39. KCM Calibration :

KAMOER large flow pump calibrating. Please take a 100ml measuring cup and place it on the baking soda supplement output. Then press the "Calibrate pump now" button. When the button is pressed, the pump will start to operate for about 20 seconds. When the pump stops, please observe the output in the measuring cup. For example, 68ml, then fill this value into the "Output ADJ:" field, press "SAVE" to complete the calibrate.

40. Network Setup :

If KHG failed to connect to your network DHCP, or if the network does not use DHCP, KHG will use these designated IP, Submask, and Gateway setting. Please note, if your network already has DHCP, but the DHCP server was not able to assign dynamic IP to KHG, please try and change MC5 to other values (from 1 to 255) and try again. Please note, you will not be able to see MC5 unless you are in Engineering Mode. New setting will be used when you press "Save Network" and rebooted.

NOTE :

The default IP can be changed from the LCD panel buttons. Remove power from KHG, Press and hold buttons 2 + 3 and replug in the power, KHG will make a few beeps, please release the button at this time, The default IP will be changed from 192.168.1.120 to 172.22.20.120 , 172.22.20.120 to 10.0.0.120, 10.0.0.120 to 92.168.1.120 change sequentially.

41. New PW :

Please enter new password. Password allows maximum 8 characters include spaces, numbers, letters or mixed. No special character allow. Case sensitive.

42. Confirm PW :

Please re-enter new password. Press "Change Password" to complete and store your new password. The New Password will become effective next time KHG was rebooted.

43. ENG CMD :

For special command use only. Please do not attempt to use this field unless you were instructed by the authorized dealers. If wrong values were entered 10 times, KHG will lock up and cease to operate. If this happens, KHG will have to be sent back to the manufacturer to restore normal function. Please note, this field will not display unless Engineering Mode is activated.

44. YY/MM/DD/HH/MN :

These five fields are Year, Month, Date, Hour, Minute. Upon NTP enabled, these five values will be synchronized simultaneously. But if NTP was disabled, KHG will use internal batter clock. You will have to manually enter these five fields. Press "DateTime Update" to save.

45. Clear SD Card:

Press "Clear" to initiate SD card memory purge. KHG has log feature for user analysis. However, the record log takes up memory on the SD card, and we recommend performing the SD card memory purge every 3 months. Low available SD card memory will slow down the display refresh speed. Every time you do a "Clear SD", please unplug KHG from power outlet for 3 seconds and reconnect the power cord to the electrical outlet. This will reboot the system to re-enable the logging function. Please note, this field will not display unless Engineering Mode is activated.

The Meaning of Log Field

eg: 10/07 15:07:49 W.131 %0 AK.35.00 KH :7.90

- 10/07 22:12**

Date / Time.

- W.131**

Tank Water Input Pump run how many pitches.

- %0**

optically matching agent dropped speed to assess the percentage of possible errors.

- AK.35.00**

calculated automatically supplemented 22.15 cc baking soda.

- KH :7.90**

KH value 7.90 dKH (not before adding baking soda).

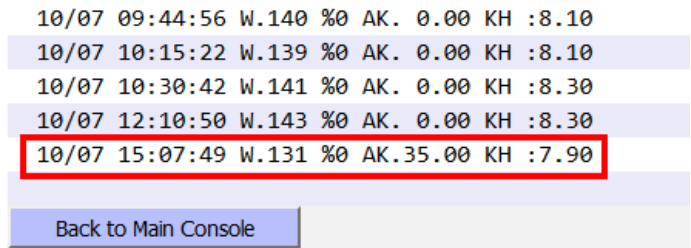

(Figure 14)

Firmware Upgrade

1. Click "ENG Mode ON" button on the main console. The tab will change to pink when it is on. (Figure 15)
2. Next, press the "System Setup" button on the main console. (Figure 16)
3. Below the Firmware Upgrade, press "SELECT .BIN FILE". (Figure 17)

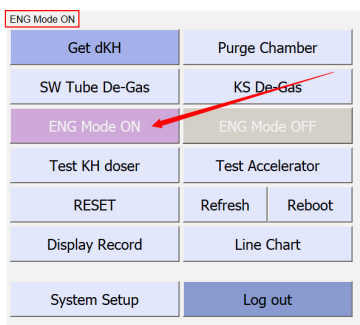

(Figure 15)

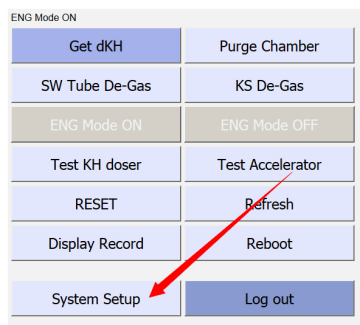

(Figure 16)

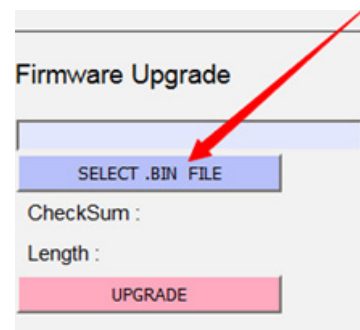

(Figure 17)

4. A pop-up window will appear in your browser in order to select the correct .BIN file. (Figure 18)

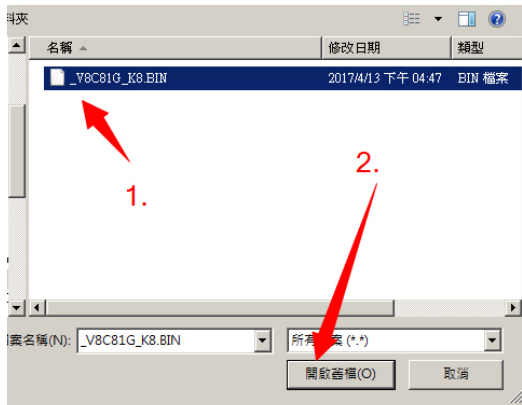

(Figure 18)

5. Please select the newest firmware file from your disk, and open it. The dialogue window will then close and the file name you selected will appear below the KHG “Firmware Upgrade”.
6. Please press the “UPGRADE” button. (Figure 19)



(Figure 19)

7. Please take special note that the “CheckSum” value on your screen should match the value on the KHG main website. If there are discrepancies of the two CheckSum values, the file you selected may be corrupted and should not be used for firmware upgrade.
8. The update progress will show up in the KHG LCD panel. The upgrade process may take a few minutes. (Figure 20)



(Figure 20)

9. In about 5 ~ 20 seconds after the progress showed 100%, KHG will make a few beeps (please be patient until you hear the beeps). Please remove the power strip from the electrical socket and reconnect the power. (Figure 21)



(Figure 21)

10. Please note, power voltage must be stable during firmware upgrade. Accidental loss of power may cause permanent damage to the KHG. If this occurs, the control board must be sent back to the manufacturer for repair.

AIM Calibration

1. AIM Expansion Module Quick Installation. (Figure 22)

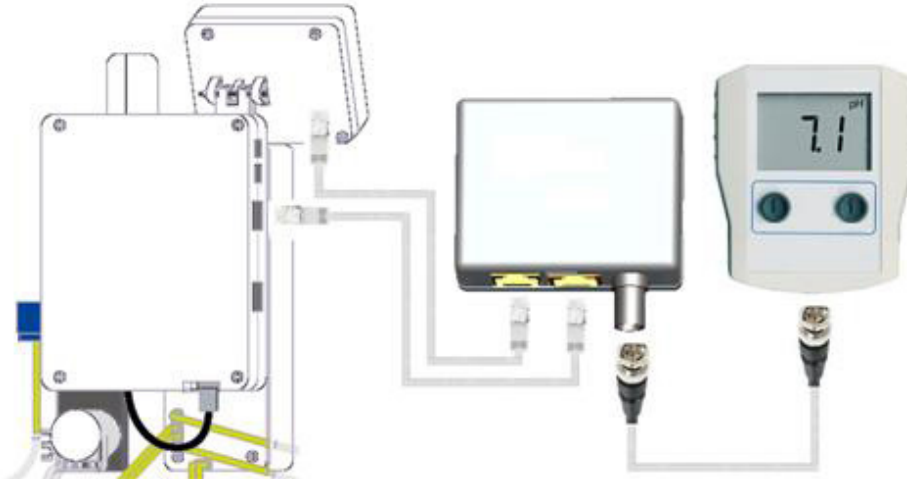

(Figure 22)

2. Software control display, please refer to Figure 23.

- S.4

Press this button, KHG will send out simulated pH4 voltage from BNC connector of AIM for 30 seconds. Please complete pH4 calibration on the third party aquarium system controllers during this 30 seconds.

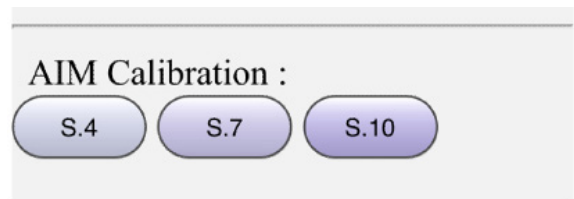

(Figure 23)

- S.7

Press this button, KHG will send out simulated pH7 voltage from BNC connector of AIM for 30 seconds. Please complete pH4 calibration on the third party aquarium system controllers during this 30 seconds.

- S.10

Press this button, KHG will send out simulated pH10 voltage from BNC connector of AIM for 30 seconds. Please complete pH4 calibration on the third party aquarium system controllers during this 30 seconds.

3. Seconds count down will be displayed on the control panel when AIM send out the simulated target voltage, as Figure 24.



(Figure 24)

4. Normally you only need to make pH calibration from pH4 to pH7, or pH7 to pH10. Please refer to the user manual of the third party aquarium system controller for instruction.
5. Due to the conversion of digital signal to analog signals, minor loss of signals are inevitable. This could result in 0.05 dKH discrepancy.
6. If KHG detected errors, pH5 signals will be transmitted as warning signal, and will not return back to the correct value unless user cleared the error message.

Error Message and Troubleshooting

1. SW>ERR : System water intake error

1. Please go to control menu and press "SW Tube De-Gas" and also check if the Tank Water Input Pump is functioning.
2. Please check all sections of tank water intake tube and make sure they are free of blockage.
3. Please gently open the "Reaction Chamber" and make sure the white water level sensor is freely movable up and down.
4. Sensor may be malfunctioned. Please contact your dealer.

2. SW<ERR or PW<ERR : Reaction chamber water purging error

Please try to upgrade your KHG firmware to V8FW.H6A8VC or above.

Press the "Purge Chamber" button again on the main screen. When the KHG occur "SW<ERR" alarm, please slowly remove the reaction chamber and observe.

If there is sea water (greater than 1cc)

1. Press "Purge Chamber" on the main screen and check if the center shaft of the doser pump motor is running correctly ?
2. If the center shaft is running, does the three white idlers that are attached follow the rotation ?
3. If the center shaft is running, but the three white idlers that are attached are "not rotating" , That is the slippage, please refer to the URL <http://www.khguardian.com/videos.php> for the method "How to reduces wheel slip" video to improve this.

If the reactor is in a state without sea water (less than 1cc)

1. Please confirm that the white (or red) level floats up and down smoothly ? Whether the float is stuck at the upper vertex, Caused KHG to misjudge that seawater has not been discharged ?
2. Please confirm that the float has slipped to the lower vertex (below the liquid level sensor lens) and make KHG entry the engineering mode (ENG mode is ON).
3. Execute the engineering command "FWON".
4. If at this time KHG starts to emit continuous B, B, B sounds, Or when the word "-FULL-" appears on the LCD screen, This represents the KHG's level sensor voltage offset and needs to be calibrate.
5. Please refer to the URL <http://www.khguardian.com/videos.php> for the calibrate method "How to recalibrate level sensor." video.

If still can't solve, please contact your dealer.

3. **KS_ERR : KRS solution suction error**

1. Please check if the KRS solution has depleted and needs replacement.
2. Please check all sections of KRS solution intake tube and make sure they are free of blockage.
3. Please go to control menu and press "KS De-Gas" and also check if the KRS pump is functioning.
4. If the KRS pump is turning, please look into the observation window and check if the drop sensor light is blinking when each drop of the KRS solution is dropping. (One short blink, One long blink)
5. Sensor may be malfunctioned. Please contact your dealer.
6. Please listen carefully, does the KRS pump have a running sound ? If there is no sound, then the motor is damaged.

4. **KH>ERR : KH value high error**

1. This error message indicates the tested value is 1.5 dKH larger than the "KH auto correction" setting. System would recognize this as abnormality.
2. Please check if your "KH auto correction" setting is a reasonable.
3. Please check if your KRS solution tube has too much air bubbles.
4. Please check if the pH probe are secured at proper depth.
5. Please check if the dilution ratio of your sodium bicarbonate solution is correct.
6. If all settings are correct, please contact your dealer.

5. **KH<ERR : KH value low error**

1. This error message indicates the tested value is 1.5 dKH lower than the "KH auto correction" setting. KHG will stop dispensing Sodium Bicarbonate until this error has been cleared.
2. Please check if your "KH auto correction" setting is a reasonable.
3. Please check if your KRS solution tube has too much air bubbles.
4. Please check if the pH probe are secured at proper depth.
5. Please check if the dilution ratio of your sodium bicarbonate solution is correct.
6. If all settings are correct, please contact your dealer.

6. **AC_ERR : KH accelerator motor error**

1. Opening the Reaction Chamber, click on "Test Accelerator" or enter the engineering command "ACTST" to rotate the accelerator motor and see if the magnetic stirrer is spinning ?
2. Use the "ACTST" engineering command because it can be started for one minute, and the longer operation time will be easier to observe.
3. If there is no rotation, so, obviously the accelerator motor is broken and needs to be replaced.



7. pH<ERR : pH reading low error

1. This error message will occur if the pH reading is below 4.5. Alarm will activate.
2. Please check if the pH probe is properly secured in the socket.
3. Please execute the pH probe calibration procedure.
4. Please gently open the "Reaction Chamber" and check if it is dry inside.
5. If the "Reaction Chamber" is dry, please check the water level sensor if it can move up and down freely.
6. If all settings are correct, please contact your dealer.

8. pH>ERR : pH reading high error

1. This error message will occur if the pH reading is higher than 8.8. Alarm will activate.
2. Please check if the pH probe is properly secured in the socket.
3. Please execute the pH probe calibration procedure.
4. If all settings are correct, please contact your dealer.

9. TL_ERR : KRS solution drip interval is too long

1. This error message will occur if the intermittent air in KRS tube.
2. Please go to control menu and press "KS De-Gas" function to vent the air.

10. TS_ERR : KRS solution drip interval is too short

1. The reagent drip observation lens may be contaminated or malfunction.
2. Please refer to <http://www.khguardian.com/videos.php> "How to clean the drug drop lens" video perform a basic cleanup.
3. If you still can't rule it out, please contact your dealer.

11. KHOV12_ERR : KH value exceeds 12 dKH

1. KH value exceeds the range that KHG can measure.
2. The reagent dilution ratio is wrong, too thin.
3. Please use a 3rd party test kit to verify that your seawater KH is above 12 dKH.
4. Re-diluting new reagents in the correct ratio.

Additional User Instructions

1. Upon initial assembly and installation, please make sure to perform 5 (five) dKH readings to ensure optimal performance and accuracy.
2. Upon using KHG, at any time if you wish to move KHG, you must use the "Purge Chamber" function to completely drain out all liquids in the Reaction Chamber. Moreover, please detach and invert the Reaction Chamber from the unit and pat dry the insides with paper towel. Failure to do so may cause the corrosive salt water to spill and may damage the parts of KHG. In severe cases, the damage maybe permanent.
3. Only use KHG approved pH probe. Non-approved pH probe would result inaccuracy. If possible, please always have a spare pH probe at hands ready to use. We recommend exchange the pH probe every three months, and perform pH4 and pH7 calibration every time at the exchange. When removing a pH probe for storage, you must thoroughly clean the probe, pat dry the surface. To store the pH probe, the glass bulb at the tip of the probe must be immersed in 3M potassium chloride solution.
4. Life of pH probe is approximately 18 months, and may reduce accuracy after long exposure to salt water. Please do not allow pH probe to dry completely for 12 hours or more, it could result in permanent damage of the probe.
5. Use of non-approved KHG reagent solution is strictly prohibited. The factory supplied KH reagent is a special mixture of reagents. We carefully select reputable reagent chemical suppliers with quality certifications. Non-KHG approved reagents may damage the patent pending interference resistant rare earth material coating in the Reaction Chamber, and may result in permanent damage to the accuracy.
6. Factory supplied KHG reagent solution are concentrated. To achieve the best accuracy, users must proper dilute it. You should use 1500 grams of RODI water for dilution. Please note the unit of RODI water is grams, not milliliter. Please use a electronic scale to weigh 1500 grams of water at room temperature, and keep the error to within 0.1 grams. Each new dilution of the KHG reagents is enough for approximately 2 month, based on 4 hours test interval and about 4 grams of reagent consumed per test.
7. To best protect your reef tank inhabitants, we did not add preservatives to the factory supplied KHG reagents. However, the lack of preservatives may result in black color bacteria substances growing in the tubing. From the test result of using KHG in the last 4 years, these substances do not cause inaccuracy to the tests, and do not have negative influences to the reef tank inhabitants. If accidental diluted reagent solution exposure to your eyes or skin, please do not panic and simply rinse with large quantities of fresh tap water. Please keep KHG reagent solutions away from children at all times.
8. KHG currently is not WIFI capable due to various country regulations. You must use RJ45 network cables

to physically connect KHG to your LAN. There is a 12 V power jack already provided with KHG that can be used in conjunction with RJ45 WIFI Bridge. If user wish to make KHG WIFI capable, please contact with your seller or authorized dealer. KHG parent company does not offer WIFI related support for the users.

9. Each time KHG reboots, it will attempt to obtain time to the network time server. If not obtainable from the network server, KHG will use its internal clock. If the internal clock also fails, the date and time will display "Time N/A".
10. Due to strict regulation of mailing battery on the aircrafts, KHG will only be shipped without internal battery. For instructions how to obtain and install internal battery, please contact your dealer.
11. When positioning the KHG, the intake tube must be within 100 cm and the KHG must not be positioned below the water surface of the location of intake tube water source.
12. To prevent siphoning of tank water via KHG, the Reaction Chamber purge tube and the Sodium Bicarbonate tube must not be immersed into the tank.
13. KHG intake tube shall not be positioned to the bottom of the tank, and should be protected to prevent debris from entering into the intake tube and result in blockage in the tubing.
14. The "C" version of the KHG comes with auto supplementation of Sodium Bicarbonate. To use this feature, please prepare your Sodium Bicarbonate solution by mixing 65 grams of sodium bicarbonate powder per one liter of water. Please keep the error tolerance to within 5%.
15. We would strongly recommend to keep KHG in a protected container away from saltwater splashes. Please contact your dealers for details.
16. Please do not attempt to open the cover of the KHG other than normal cleaning along the path of the liquid tubings. Warranties are void if the KHG body cover has been opened.
17. Please do not apply lubricants to the heads of the Sodium Bicarbonate pump, Tank Water Intake Pump and Waste Water Purge Pump. Use only dry paper towels to wipe clean if necessary.
18. KHG Reagent Pump should be taken apart for lubrication every 6 months. Use only Molykote EM-30L Grease for lubrication. Other lubricants are strictly prohibited. The tubing for the peristaltic motor should be replaced at least once a year.
19. Complete system test will be performed on every KHG during factory pre-shipment tests. Salt residue may be present in the tubing upon purchase. The residue will be purged out during the initial setup.
20. KHG maybe customized according to your need. Please contact your dealer if you deemed necessary. Please do not attempt to alter KHG by yourself or the warranty will be void.

Appendix

Display Panel Short-Cuts:

1. To calibrate pH 4: Press and hold buttons 1 + 4 for 3 seconds.
2. To calibrate pH 7: Press and hold buttons 2 + 4 for 3 seconds.
3. To KS_DS_Gas: Press and hold buttons 1 + 2 for 3 seconds.
4. To SW_Tube De_Gas: Press and hold buttons 1 + 3 for 3 seconds.
5. To Purge Chamber: Press and hold buttons 3 + 4 for 3 seconds.
6. To C.W. & dKH (Get dKH): Press and hold buttons 2 + 3 for 3 seconds.
7. To release error message: Press and hold buttons 4 for 3 seconds.

Static Testing.

When you find that the KHG data values shifts too large, how to determine if the problem was caused by KHG itself, or if it was due to the instability of the tankwater?

We propose an extremely effective and fair method, which is called "Static Testing."

1. Make sure your KHG firmware has been upgraded to V8FW.H6A8VC or higher.
2. Find a bucket and put two liters of seawater from the aquarium as a fixed sample. Put the bucket separately outside and away from the aquarium (to avoid contamination).
3. Insert the KHG inlet pipe (SW.IN) into this bucket and fix it to place.
4. Put the KHG drain pipe (SW.OUT) into another empty bucket. During static testing, never let the drain (waste) water flow back into the sample bucket to cause sample contamination.
5. We suggest to set KHG to test 6 times in a row at 30 minutes interval. Alternatively, perform 6 consecutive tests (Press Get dKH immediately after each test).
6. Let KHG operate six times in a row, then observe the record file.
7. If the record shows stable dKH readings, then this KHG is trustworthy.
8. After getting stable KHG readings, please perform another KH test using any dKH test kits that you find trustworthy. After getting test kit values, then use the "Force Reverse Calibration" function to recalibrate KHG.

Changelog

V9.003(2019/02/05)

1. [Feature] Support CCM. When you want to enable this feature, please set "KH Doser Pump: " value to "2".(Please note, when using CCM, baking soda supply pump will be invalid)
2. [Feature] Auto activation. if set this value to "1", when KHG operates 15 ~ 20 times, it will self-activate once. This feature can effectively increase the sensitivity of the electrode and extend the life.
3. [Feature] Strategies for adjusting seawater sampling and emissions.
4. [Feature] Enhanced Test pretreatment procedure.
5. [Fix] S.Raise KH ml/L ability with network submask memory location conflict
6. [Fix] For modified three-wheel KRS pump, adjust the calculation method of water droplet shape.
7. [Fix] Multiple bug fixes.

V8FW.H6A8VD(2018/09/10)

1. [Fix] Fixed SW>ERR logical problem.

V8FW.H6A8VC(2018/08/15)

1. [Fix] Multiple bug fixes
2. [Feature] Check interval allowed to be shortened to 30 minutes.
3. [Feature] "Force reverse calibration" If not allowed to be executed, will show the reason.

V8FW.H6A8T(2018/06/10)

1. [Fix] Multiple bug fixes
2. [Feature] If KHG has an error, STOP for security reasons, the LCD display's pH field will change to show * ERR *, so as not to cause misunderstandings by the average user.
3. [Feature] If KHG has an error, the KH field of the LCD display will change to show "CK=" (current dKH) instead of the last successfully measured KH value, so as not to cause misunderstandings of ordinary users.
4. [Feature] Log Retry : user can set up when KHG trying to get the KH value again, is it recorded ? 0 is do not record (Default) 1 is record. If you are a newbie, we suggest that you temporarily set it to 0.
5. [Feature] > or < 1.5 Alert : If the alkalinity obtained by the KHG deviate by 1.5 dKH from your desired dKH setting ("KH auto correction") need an alert ? 0 No, 1 is YES. If you are a newbie, we suggest that you temporarily set it to 0.
6. [Feature] KH Doser Pump : user can set up which baking soda pump to use. "1" is default for built-in baking soda pump (not applicable for "M" model), "8" is Kamoer step pump (available both for "C/M" model).
7. [Feature] C.R suspend time: If the alkalinity obtained by the KHG exceed from your desired dKH setting ("KH auto correction"), After KHG restarts, suspension time (unit:minutes) required for the calcium reactor. Please note that this setting cannot be greater than Check intervals.
8. [Feature] Force reverse calibration: please put the KH value you test from 3rd party test kit in REF.KH (dKH) box then click " Force reverse calibration" then KHG will reboot itself. KHG will be enforced to accept new KH value. This function is more powerful than ADJ function, that is to say when user use this function the ADJ function will be back to "0" automobile. PLEASE MUST TO REMBER, when KHG last 3 tested KH values are out of range or any ERR message on LCD base on the safety reason KHG will not show this function on system setup page.
9. [Feature] Firmware last update date and time will be recorded and show on the system setting screen.

V8W.H6A8R (01/30/2018)

1. [Fix] M.L.Q function failure.
2. [Feature] The default IP can be changed from the LCD panel buttons. Remove power from KHG, Press and hold buttons 2 + 3 and replug in the power, KHG will make a few beeps, please release the button at this time, The default IP will be changed from 192.168.1.120 to 172.22.20.120 , 172.22.20.120 to 10.0.0.120, 10.0.0.120 to 92.168.1.120 change sequentially.

V8W.H6A8Q (01/05/2018)

1. [Feature] S. Raise KH ml / L ability: (the solution raise KH for ml / L ability) This means that whether or not any KH lift solution is used, please provide how much dKH can be increased by 1 L (1000 cc) of seawater per ml (cc) for this lift solution. The default is 2.17, because KHG recommends a 65g / 1L baking soda solution, and this baking soda solution can lift a liter of seawater 2.17dKH. Please be careful to use this function, it is very powerful but also very dangerous, wrong calculations can cause serious damage.
2. [Feature] No_SW_ERR Try: user can set up the try times when KHG get SW ERR, the default value is 2.
3. [Feature] Wash Rate : user can set up the times of clean chamber it is for the user who put KHG away from his tank. BUT IT is what we do not recommend . the default value is 2.

V8W.H6A8L (11/30/2017)

- [Fix] SW_Tube_De-Gas would run even when chamber was empty causing the unit to flash SW_ERR

V8FW.H6A8G (11/24/2017)

- [Feature] Ability to increase "ADJ KH" range.
- [Fix] Multiple bug fixes

V8FW.H6A8B (10/25/2017)

- [Feature] Increases maximum dKH value to 12
- [Fix] Second decimal value not displaying on screen when dKH above 10
- [Fix] Multiple bug fixes

V8FW.H5F6M & V8FW.H5F6C (9/14/2017)

- [Fix] Multiple bug fixes

V8PRO.H5F5 (5/22/2017)

- [Fix] Unable to specify tank size



Contact :

SALES@KHGUARDIAN.COM

SUPPORT@KHGUARDIAN.COM